

THE ARBITRAGE-FREE EQUILIBRIUM PRICING OF LIABILITIES
IN AN INCOMPLETE MARKET:
APPLICATION TO A SOUTH AFRICAN RETIREMENT FUND

BY R.J. THOMSON

ABSTRACT

In prior work by the author the method of pricing the liabilities of a financial institution by means of dynamic mean–variance hedging is applied to an incomplete market that is nevertheless in equilibrium with homogeneous expectations. In subsequent work a long-term equilibrium model is developed and parameterised for the South African market. The aim of this paper is to apply the latter model to the pricing method with a view to quantifying the effects of non-additivity due to incompleteness, guarantees implicit in reasonable expectations of pension increases and the sensitivity of the price of illustrative liabilities to the parameters of the model. The application is to retirement-fund benefits in the South African market.

In an unpublished application of the pricing method it was found that, except for quite short-term liabilities, the computational demands of the pricing algorithm became excessive. The main reason for this was that the algorithm calls for simulations within simulations: for each year of the term of liabilities, a large number of simulations is required, and for each such simulation another large number of simulations is required. In this article consideration is given to the reduction of the computational demands of the algorithm.

CONTACT DETAILS: Robert Thomson, professor, School of Statistics and Actuarial Science, University of the Witwatersrand, Private Bag 3, WITS, 2050. tel +27 (0) 11 6465332, fax +27 (0) 11 7176285, e-mail rthomson@icon.co.za

KEYWORDS: Market value of liabilities; Dynamic mean–variance hedging; Equilibrium market models; Incomplete markets

1. INTRODUCTION

In Thomson (2005) the method of pricing the liabilities of a financial institution by means of dynamic mean–variance hedging is applied to an incomplete market that is nevertheless in equilibrium with homogeneous expectations (the TP1 model). That paper gave no illustration of the application of the model, because the TP1 model requires a long-term equilibrium model of the major constituents of the market portfolio and no such model existed that could be used for that purpose. In order to operationalise the TP1 model it was therefore necessary to develop an equilibrium model.

In Thomson & Gott (unpublished) a long-term equilibrium model (the TGESA1 model) is developed and parameterised for the South African market and in Thomson &

Gott (forthcoming) a similar model (the TGEUK1 model), with some improvements, is developed and parameterised for the United Kingdom market. These models needed to incorporate a model of the market portfolio that was consistent with the requirements of equilibrium. (In particular, expected returns on the market and the volatility of those returns had to be expressed as ex-ante values. For example, expected one-year returns on the market conditional on information at the start of a year should not be less than the one-year risk-free rate.) Simple models of the market portfolio were considered sufficient for the purposes of publication of the TGESA1 and TGEUK1 models and those papers therefore incorporated tentative models of the market portfolio (the TGMSA1 and TGMUK1 models respectively). However, in order to operationalise the TP1 model, it was necessary to develop credible models of the market portfolio.

In Thomson (unpublished b), after consideration of alternative specifications of the process governing the return on the market portfolio, a refined model of the South African market portfolio (the TMSA2 model) is developed for predictive purposes. Similarly, in Thomson (unpublished a) a refined model of the UK market portfolio (the TMUK2 model) is developed. The aim of this paper is to apply the TP1 model to the TGESA1 and TMSA2 models with a view to quantifying the effects of:

- non-additivity due to incompleteness;
- guarantees implicit in reasonable expectations of pension increases; and
- the sensitivity of the price of illustrative liabilities to the parameters of the model.

For that purpose it was necessary to consider some further amendments both to the TGESA1 model and to the TMSA2 model; the amended equilibrium model is referred to as the TGSA2 model and the amended market-portfolio model as the TMSA3 model. The amendments are explained in section 3. For ease of reference, the models referred to above are listed in an appended glossary. The application is to retirement-fund benefits in the South African market.

The TP1 model assumes that a discrete, stochastic state-space model is available of the variables required to determine, by means of an asset–liability model, the liability cash flows and the return on all relevant categories of assets during a particular year for given values of the variables at the start of that year. While the TGESA1 and TGEUK1 models include models of the relevant asset categories, they do not include models of the liabilities. This paper illustrates the development of such a model. Because the modelling of the liabilities of different financial institutions—and even those of different retirement funds—may be quite different, the development (or at least the parameterisation) of a model of the liabilities may differ from fund to fund.

In an earlier, unpublished application of the TP1 model¹ it was found that, except for quite short-term liabilities, the computational demands of the pricing algorithm became excessive. The main reason for this was that the algorithm calls for simulations within simulations: for each year of the term of liabilities, a large number of simulations is required, and for each such simulation another large number of simulations is required. In this article consideration is given to the reduction of the computational demands of the algorithm. This is achieved partly by amendments to the specification of the model and

¹ Kransdorff, S.H. (unpublished). The pricing of liabilities in an incomplete market: a practical application. Unpublished honours research paper, School of Statistics and Actuarial Science, University of the Witwatersrand, 2005

partly by changes in programming methods, software and hardware. The amended specification is referred to as the TP2 model. The specification is given in greater detail than in Thomson (2005).

In the debate between the economic valuation of retirement-fund liabilities using bond yields (Head et al., 2000: method 3) and the use of bond yields plus a risk premium (ibid.: method 4), it may be argued (e.g. Exley, Mehta & Smith, 1997) that, because such liabilities cannot be completely hedged by means of bonds, there is room for the inclusion of equities in an optimal portfolio. Because the expected yield on equities is greater than that on bonds, this would justify the use of a risk premium in the valuation of the liabilities. The size of that risk premium may be subjectively determined or it may be determined with reference to the actual proportion of the fund's investments that is in equities so as to achieve stability in funding levels (Head et al, op. cit.: 106–8). On the latter basis, the effect of the risk premium may be a fairly substantial reduction in the liabilities (ibid.: 89). Under the approach adopted in this paper, it may be expected that the effect of allowing for equities (and of departure from a matched position in bonds) will be relatively small. This is due to a different criterion for the exposure to equity: instead of starting with a subjectively determined exposure, the method in this paper seeks to optimise that exposure. In essence the approach here is that, only to the extent that the trustees are unable to avoid risk should the valuation of the liabilities allow for a risk premium (Thomson, 2002). (In order to recognise the nature of their responsibilities, reference is made in this paper to 'trustees' rather than to the expression 'board' used in the Pension Funds Act².) It may therefore be expected that the effect will be a considerably smaller departure from the value based on risk-free bond yields than that produced by the risk premiums typically used.

Other literature on the subject of this paper is reviewed in the abovementioned papers and is not revisited here.

In section 2 the liabilities are specified as well as the models of salaries and mortality, which are required for the projection of the liabilities. Section 3 discusses the modelling of assets and price inflation using the market-portfolio and equilibrium models. Section 4 explains the TP2 pricing model. Section 5 presents and discusses the results of the pricing, including the sensitivity of the price to the parameters and observations regarding the control parameters and the speed of convergence. Section 6 concludes, with some suggestions for further research.

2. LIABILITIES

2.1 SPECIFICATION

For a member aged x in service at time 0, we let P_{x0} denote the pension accrued for service to time 0, conditional on information at that time. We define:

$$P_{x0} = \pi n S_{x0}; \quad (1)$$

where:

- π is the rate of pension accrual per year of service;
- n is the length of service of that member in years from date of entry to time 0; and
- S_{xt} is the member's annual salary during year t .

² Pension Funds Act 24 of 1956 as amended

As time passes, the member receives salary increases, and the accrued pension for service to time 0 increases proportionately. It is assumed that salary increases are granted annually in arrear. When the member retires the accrued pension

$$P_{x,R-x-1} = \pi n S_{x,R-x-1} \quad (2)$$

becomes payable. This is based on the salary during the last year of service preceding her attainment of retirement age R . Thereafter, increases may be granted to pensions. For the purposes of this paper it is assumed that:

$$\pi = 0,02; \text{ and}$$

$$R = 65.$$

Let P_{xt} denote the pension payable to a member (whether that member is an active member at time 0 or a pensioner) at time t in respect of service to time 0, and let c_{xt} denote the cash flow in year t in respect of the member for such service, conditional on information at that time. We define:

$$c_{xt} = \frac{1}{2}(p_{x,t-1} + p_{xt})P_{xt} \quad (3)$$

where:

p_{xt} is the probability that the pensioner will be alive at time t ; and

P_{xt} is the pension payable during year t .

To approximate annual payment, we assume that half the pension is payable at the start of the year and half at the end, subject at each date to the member's survival. No allowance is made for exit from the fund—either by death or otherwise—before the attainment of the retirement age; it is assumed that the price of the liabilities in respect of the member at the time of occurrence of such a contingency will be paid by the fund at that time and any extra benefits will be current-costed. The probabilities in equation (3) therefore allow for mortality only after the retirement age. In the pricing of the liabilities of the fund, no allowance is made for future service; it is assumed that the cost of benefits in respect of future service will be met by future contributions. Allowance is, however, made for future salary increases. Both the salary and the pension are expressed in real terms—i.e. deflated to time 0 using an index of consumer price inflation. Each member's salary (and therefore her accrued pension for service to time 0) is a stochastic process. The rates of pension increase and mortality are also stochastic processes. These stochastic processes are discussed below.

It is assumed that mortality risks can be pooled, either by reinsurance or otherwise, on the same basis as that used in this paper. In the absence of arbitrage, this means that, whether or not the fund actually undertakes such pooling, the price of the liabilities is determined as if it did. This means that, conditionally on mortality rates at the start of a year, mortality risks are diversifiable during that year.

While the above specification of benefit accrual contemplates a defined-benefit retirement fund using the projected unit method of funding, it could equally be applied to a defined-contribution retirement fund using such a specification as its basis for the accrual of reasonable benefit expectations.

Besides pricing the liabilities accrued, we must price the current annual rate of benefit accrual. The rate of benefit accrual at time 0 in respect of current service is:

$$P'_{x0} = \pi S_{x0} \quad (4)$$

and the cash flow in year t in respect of a member for service accruing at time 0, conditional on information at that time, is:

$$c'_{xt} = \frac{1}{2}(p_{x,t-1} + p_{xt})P'_{xt} \quad (5)$$

The pricing of the liabilities for service to time 0 gives the value of the assets required to reflect the price of the accrued liabilities and the pricing of the liabilities for service currently accruing gives the amount of contributions required for liabilities currently accruing.

As explained in Thomson (2005), in order to determine an accurate price of the liabilities of a financial institution in an incomplete market, the liabilities for each member should be modelled stochastically, allowing for its interdependence with the other liabilities and with the assets. This would necessitate an additional modelling dimension for every member. Even for a small fund, the computational demands would become excessive. Some simplification is therefore necessary.

Also, as explained in that paper, the prices of liabilities in an incomplete market are not generally additive. However, if a fund is divided into cohorts of members, then, as the number of members in each cohort increases, the error due to non-additivity may be expected to tend to a constant proportion of the price of the liability of that cohort.

In this paper an illustrative fund has been reduced to seven model-point age cohorts. The fund data are shown in Tables A.1 and A.2 of Appendix A. At time 0, at each age, half the members and pensioners at each age are assumed to be female and half male; the data are assumed to be identical. While the data have been derived from an actual fund, they have been stylised to avoid identification.

Table 1. Model-point data

Accrued pensions			Accruing pensions		
age cohort	no. of members	pensions (R'000)	age cohort	no. of members	pensions (R'000)
x	N_x	P_x	x	N_x	P'_x
25	360	2 394	25	360	642
35	1680	28 844	35	1680	3 480
45	2040	51 896	45	2040	4 230
55	1804	54 706	55	1804	3 402
65	1442	64 932	62	762	1 288
75	1010	49 442			
85	600	20 864			

We assume that, at time 0, the fund comprises four age cohorts of active members and three age cohorts of pensioners. In determining the model-point data, the fund data have been grouped into the nearest cohort age so that, in each cohort, the total number of

members, annual salaries and accrued pensions are equal to those of the fund members grouped into that cohort. The model-point data for the cohorts used are shown in Table 1.

2.2 SALARY INCREASES

We let the real salary during year t of active member m at time 0 be denoted by:

$$S_{mt} = S_{m,t-1} \exp(\xi_t + \zeta_{mt}); \quad (6)$$

where:

ξ_t is the annualised force of the general increase in year t , such that:

$$\xi_t = \mu_\xi + b_{\xi_1} \eta_{3t} + b_{\xi_2} \eta_{7t} + \sigma_\xi \varepsilon_{\xi t}; \quad (7)$$

$$\mu_\xi = E\{\xi_t\}; \quad (8)$$

η_{3t} is the inflation innovation in the equilibrium model and b_{ξ_1} is the associated volatility;

η_{7t} is the innovation arising from the notional risky assets comprising the market portfolio, such that:

$$\eta_{7t} = \sum_{i=1}^6 a_{i7} \varepsilon_{it}; \quad (9)$$

$$\sum_{i=1}^6 a_{i7} = \sqrt{6}; \quad (10)$$

and b_{ξ_2} is the associated volatility;

σ_ξ is the residual volatility of ξ_t ;

$$\varepsilon_{\xi t} \sim N(0,1);$$

$$\text{cov}(\varepsilon_{\xi t}, \varepsilon_{\xi t'}) = \text{cov}(\varepsilon_{\xi t}, \varepsilon_{it}) = \text{cov}(\varepsilon_{\xi t}, \varepsilon_{it'}) = 0 \text{ for } t' \neq t \text{ and } i = 1, \dots, 6;$$

ζ_{mt} is the additional force of increase to member m in year t , such that:

$$\zeta_{mt} = \mu_{\zeta_{x_m}} + \sigma_{\zeta_{x_m}} \varepsilon_{\zeta mt}; \quad (11)$$

$$\mu_{\zeta_{x_m}} = E\{\zeta_{mt}\};$$

$$\sigma_{\zeta_{x_m}}^2 = \text{var}\{\zeta_{mt}\};$$

$$\zeta_{mt} \sim N(0,1);$$

$$\text{cov}(\varepsilon_{\zeta mt}, \varepsilon_{\zeta mt'}) = \text{cov}(\varepsilon_{\zeta mt}, \varepsilon_{\zeta m't}) = \text{cov}(\varepsilon_{\zeta mt}, \varepsilon_{it}) = \text{cov}(\varepsilon_{\zeta mt}, \varepsilon_{it'}) = 0 \text{ for } t' \neq t \text{ and } i = 1, \dots, 6; \text{ and}$$

$$\text{cov}(\varepsilon_{\zeta mt}, \varepsilon_{\xi t}) = \text{cov}(\varepsilon_{\zeta mt}, \varepsilon_{\xi t'}) = 0 \text{ for } t' \neq t.$$

In practice, the values of the constants and parameters in the above formulation will vary from fund to fund. For the purposes of this paper, the following values were assumed:

$$\mu_\xi = 0,01$$

$$b_{\xi_1} = -0,005;$$

$$b_{\xi_2} = 0,005;$$

$\sigma_{\xi} = 0,03$; and

$$a_{i7} = \frac{1}{\sqrt{6}}.$$

It was also assumed that:

$$\mu_{\zeta x} = \alpha_{\mu_{\zeta}} + \beta_{\mu_{\zeta}} \exp(-\lambda_{\mu_{\zeta}} x); \text{ and} \quad (12)$$

$$\sigma_{\zeta x} = \alpha_{\sigma_{\zeta}} + \beta_{\sigma_{\zeta}} \exp(-\lambda_{\sigma_{\zeta}} x); \quad (13)$$

where:

$$\alpha_{\mu_{\zeta}} = 0,016;$$

$$\beta_{\mu_{\zeta}} = 0,5;$$

$$\lambda_{\mu_{\zeta}} = 0,1;$$

$$\alpha_{\sigma_{\zeta}} = 0,042;$$

$$\beta_{\sigma_{\zeta}} = 0,5; \text{ and}$$

$$\lambda_{\sigma_{\zeta}} = 0,08.$$

These parameters are based on the experience of the illustrative fund referred to in section 2.1. The values of $\mu_{\zeta x}$ and $\sigma_{\zeta x}$ are shown in Figure 1 as the ‘mean’ and ‘standard deviation’ respectively.

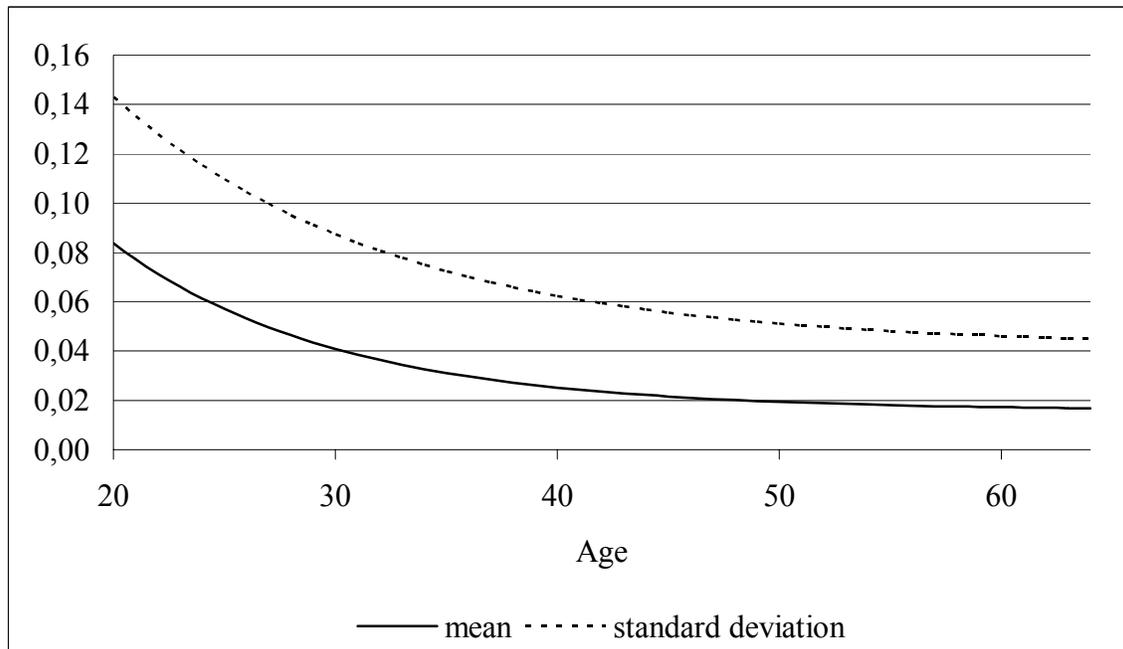

Figure 1. Mean and standard deviation of the additional force of increase to a member

Since we are modelling real salary increases, $b_{\xi 1}$ will be negative: the greater the rate of inflation, the less likely it will be that salary increases will match it. The value is

arbitrary; in absolute value it is very small in relation to σ_M , the volatility of the market portfolio (cf. section 3.1 below). More importantly, it is small in relation to σ_ξ . The values of a_{i7} are taken as equal so that the dependence of salaries on the assets is expressed through the market portfolio itself; the value chosen gives a standard deviation of 1, so that $b_{\xi 2}$ represents the assumed volatility. The latter is arbitrary; as for b_{S1} it is very small in relation to σ_M , and, again more importantly, it is small in relation to σ_ξ .

Let G_{xt} denote the set of members aged x at the start of year t and let M_{xt} denote the number of members in that set. Then the mean and variance of:

$$\bar{\zeta}_{xt} = \frac{1}{M_{x,t-1}} \sum_{m \in G_{xt}} \zeta_{mt} \quad (14)$$

is normal with mean and variance:

$$\mu_{\bar{\zeta}_{xt}} = \mu_{\zeta_x}; \text{ and} \quad (15)$$

$$\sigma_{\bar{\zeta}_{xt}}^2 = \frac{\sigma_{\zeta_x}^2}{M_{x,t-1}}. \quad (16)$$

Conditionally on $S_{x,t-1}$ and ξ_t , we may therefore simulate a value of

$$S_{xt} = S_{x,t-1} \exp(\xi_t + \bar{\zeta}_{xt}) \quad (17)$$

for the cohort by sampling $\bar{\zeta}_{xt}$ from a normal distribution with the above mean and variance. Because $S_{x,t-1}$, ξ_t and $\bar{\zeta}_{xt}$ are independent, equation (17) gives an unbiased sample.

We assume that the data include salary increases just received and that, thereafter salary increases take place annually in arrear, so that, for a retiring member:

$$S^R = S_{x,R-x-1}. \quad (18)$$

This means that there is no further salary increase in the year of age 64.

2.3 PENSION INCREASES

We let the real pension during year t be denoted by:

$$P_t = P_{t-1} \exp\{\max(0, -\gamma_t)\}. \quad (19)$$

The requirement that the real force of salary increase be at least $-\gamma_t$ avoids negative nominal increases when inflation is negative.

2.4 MORTALITY

There is no published table of pensioner mortality in South Africa. Dorrington & Tootla (2007) gives South African annuitant mortality rates based on data in respect of the period from 1996 to 2000, tabulated as SAIFL98 and SAIML98 for females and males respectively.

The Faculty and Institute of Actuaries have published mortality tables based on lives experience during the period 1999–2002 both for immediate annuitants (IFL00 and IML00) and for pensioners (those for normal pensioners being PNFL00 and PNML00).

For the purposes of this paper, the commencing force of pensioner mortality for the year of age x —i.e. the age interval $[x, x + 1)$ —was taken as:

$$v_{\{x\}}^{SAP98} = \frac{v_{\{x\}}^{PNL00}}{v_{\{x\}}^{IL00}} v_{\{x\}}^{SAIL98}, \quad (20)$$

where:

- $v_{\{x\}}^{PNL00}$ is the corresponding value from the PNFL00 or PNML00 table;
- $v_{\{x\}}^{IL00}$ is the corresponding value from the IFL00 or IML00 table; and
- $v_{\{x\}}^{SAIL98}$ is the corresponding value from the SAIFL98 or SAIML98 table.

In this formulation $v_{\{x\}}$ denotes in each case the average (or equivalently the aggregate) force of mortality over the year of age x ; i.e.:

$$v_{\{x\}} = -\ln(1 - q_x). \quad (21)$$

In the actuarial literature this is often (as in Dorrington & Tootla, op. cit.) shown as $\mu_{x+\frac{1}{2}}$.

Whereas the latter represents an approximation to a value at exact age $x + \frac{1}{2}$, the usage in this paper represents an exact value of the aggregate force over the year.

The results are shown in Table A.3 of Appendix A.

Allowance was made for stochastic improvement in mortality by means of the process:

$$v_{\{x+t\}}^{SAP} = v_{\{x+t-1\}}^{SAP} \exp(\chi_{vt}); \quad (22)$$

where:

$v_{\{x+t\}}^{SAP}$ represents the force of pensioner mortality during year $2008 + t$ for a pensioner of age x at the start of 2008;

$$v_{\{x\}}^{SAP} = v_{\{x\}}^{SAP98} \exp(10\mu_v); \quad (23)$$

$$\chi_{vt} = \chi_{v,t-1} + \mu_v + b_v \eta_{7t} + \sigma_v \varepsilon_{vt}; \quad (24)$$

μ_v is the expected rate of increase in mortality (which will be negative to allow for improvement);

$\varepsilon_{qt} \sim N(0,1)$; and

$$\text{cov}(\varepsilon_{vt}, \varepsilon_{vt'}) = \text{cov}(\varepsilon_{vt}, \varepsilon_{it'}) = \text{cov}(\varepsilon_{vt}, \varepsilon_{it'}) = 0 \text{ for } t' \neq t \text{ and } i = 1, \dots, 6.$$

The purpose of the definition of $v_{\{x\}}^{SAP}$ as in equation (23) is to allow for improvement in mortality in the 10 years that elapsed from 1998 to 2008. Again, the values of the constants and parameters in the above formulation will vary from fund to fund. For the purposes of this paper, the following values were assumed:

$$\mu_v = -0,004;$$

$$b_v = -0,001; \text{ and}$$

$$\sigma_v = 0,005.$$

Dorrington & Tootla (2007) suggest an average reduction in mortality equivalent to one year of age for every 20 years projected. This is approximately equivalent to the above value of μ_v . The values of b_v and σ_v are arbitrary; the latter, representing the independent volatility of the annual improvement is small in relation to μ_v and the former, representing the additional volatility arising from the market portfolio, is even smaller.

3. ASSETS AND PRICE INFLATION

3.1 THE MARKET-PORTFOLIO MODEL

In the TMSA2 model the return on the market portfolio is:

$$\delta_{M;t} = g\delta_{I;t} + \sigma_M \varepsilon_t; \quad (25)$$

where:

$$g = 1,39;$$

$$\sigma_M = 0,159;$$

and $\varepsilon_t \sim N(0,1)$ is serially independent.

In the use of the model for predictive purposes, it is inevitable that, in a small minority of cases, $\delta_{I;t}(0) < 0$. As explained in Thomson & Gott (forthcoming), negative market prices of risk may be avoided in such cases by using the TGMUK1 model:

$$\delta_{M;t} = \mu_{M;t} + \sigma_M \varepsilon_t; \text{ and} \quad (26)$$

$$\mu_{M;t} = g\delta_{I;t}(0) \text{ for } \delta_{I;t}(0) > 0 \quad (27)$$

$$= \delta_{I;t}(0) \text{ otherwise.}$$

The TMSA3 model used in this paper comprises the TGMUK1 formulation with the TMSA2 parameterisation.

3.2 THE EQUILIBRIUM MODEL

In the TGESA1 model index-linked and conventional zero-coupon bonds are modelled by means of variables $b_{I0t}(s)$ and $b_{C0t}(s)$ respectively. As explained in ¶3.2.3 of Thomson & Gott (unpublished),

$$\frac{b_{I0t}(s)}{s} \text{ and } \frac{b_{C0t}(s)}{s}$$

represent the expected yield curve at time t , conditional on information at time $t - 1$. It has been found simpler to use the variables $Y_{It}(s)$ and $Y_{Ct}(s)$, such that

$$\frac{Y_{It}(s)}{s} \text{ and } \frac{Y_{Ct}(s)}{s}$$

represent the actual yield curve at time t . The parameterisation of the model is not affected by this amendment.

As stated in Thomson & Gott (unpublished), the parameters required for the TGESA2 model, incorporating the TMSA2, model are as follows:

– for all required values of s :

$$Y_{I_0}(s) = -\ln\{P_{I_0}(s)\} \text{ and } Y_{C_0}(s) = -\ln\{P_{C_0}(s)\}, \quad (28)$$

$P_{I_0}(s)$ and $P_{C_0}(s)$ being the prices at time 0 of s -year index-linked and conventional bonds respectively; and

$b_{I_j}(s)$ and $b_{C_j}(s)$, i.e. the sensitivity of the yield on s -year index-linked and conventional bonds respectively to the j th factor for $j = 1, 2$;

- σ_M , the volatility of the return on the market portfolio;
- g , the sensitivity of ex-ante expected returns on the market portfolio to positive risk-free returns;
- b_γ , the volatility of the force of inflation in excess of conditional ex-ante expected inflation;
- $b_{E;1}$, the covariance of the return on equities with the return on the market portfolio, expressed relative to the latter; and
- for $i = 1, \dots, N$ and $j = 1, \dots, 6$: a_{ij} , the sensitivity of the j th factor to the i th notional risky asset.

In this paper, as in its precursors, the ‘return’ on an asset during a particular year is defined as the average instantaneous real rate (or ‘force’) of return during that year. To avoid arbitrage, the TGESA2 model of the return on the market portfolio is made up of notional risky assets (six in number), each with equal ex-ante volatility and expected return. Realisations of the returns on these assets drive six factors, which in turn drive the returns on the assets. Index-linked and conventional term structures are each driven by two, and the force of inflation and the return on equities (in excess of their conditional ex-ante expected values) each by another.

A summary of the amended model (denoted TGESA2) is given in Appendix C.

4. PRICING

4.1 PRICING METHOD

The pricing method follows the TP1 model. In that model the price of the liabilities at time t depends on a state-space vector at that time; in Thomson (2005) the choice of a state-space vector is not addressed. The pricing method involves primary simulations of that vector to a time horizon at which the liabilities are extinguished, followed by secondary one-year simulations from each node of the primary simulations. Figure 2 depicts primary simulations from time 0 to time $T - 1$ (where T is the time of the last possible payment to a surviving member in terms of the mortality table used) and secondary simulations from a primary simulation node at time $t - 1$. No primary simulations are necessary for the final year. Secondary simulations are made from each primary simulation node.

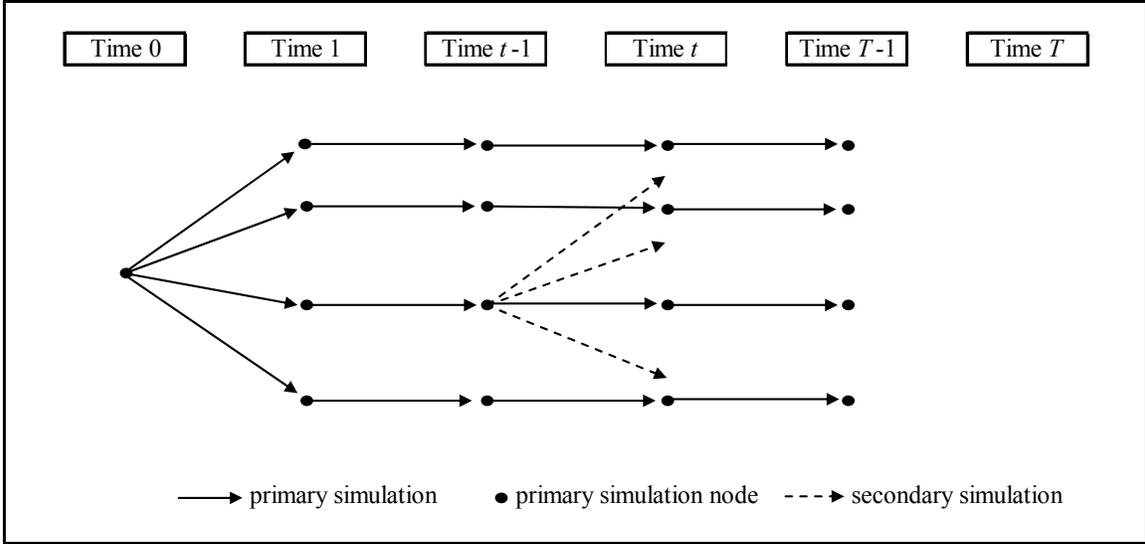

Figure 2. Primary and secondary simulations

First let us consider the primary simulations. As shown in Figure 3, these comprise simulations of the state-space vector \mathbf{x}_i . In principle the state-space vector comprises sufficient information to define the state of the world in the i th simulation at time t . The definition of the state-space vector is considered further in section 4.2 below.

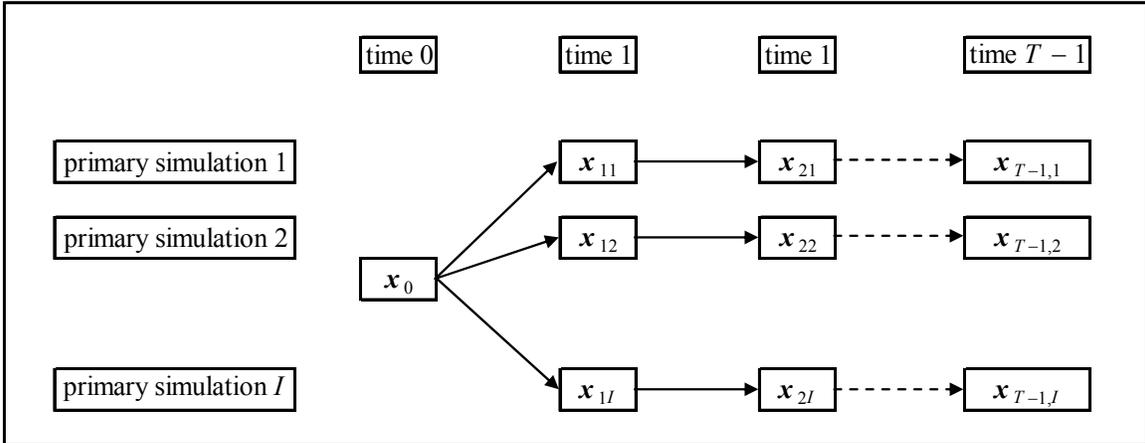

Figure 3. Primary simulations of the state-space vector

Now let us consider the secondary simulations. These proceed backwards from the time horizon T , where the last payment is made, so we first consider the secondary simulations in year T . In Figure 4a we use an asterisk to distinguish variables derived from secondary simulations from those derived from primary simulations. Thus the state-space vector $\mathbf{x}_{T-1,i}$ arises from the i th simulation at time $T-1$, whereas \mathbf{x}_{Tj}^* arises from the j th subsequent secondary simulation at time T . At the latter simulation, since the state of the world is defined, we can determine the fund's cash flows in respect of the final benefits then due, and there is no further liability. Once we have completed all J simulations from the primary simulation node, we have a sample multivariate distribution of the price of the liabilities at time T and the returns on assets during year T . Using

mean–variance hedging and the equilibrium assumptions of the capital-asset pricing model (CAPM) as in the TP1 model and as summarised in Appendix D, we may then determine the price of the liabilities at the start of year T after all payments then due. This is depicted in Figure 4b. To this price we add the payments due at the end of the previous year.

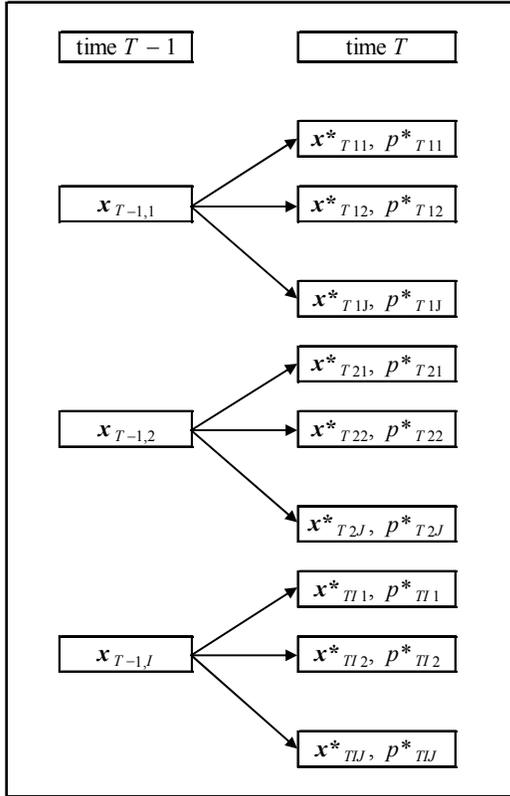

Figure 4. Secondary simulations:
Figure 4a. Simulation of state space and prices at end of final year

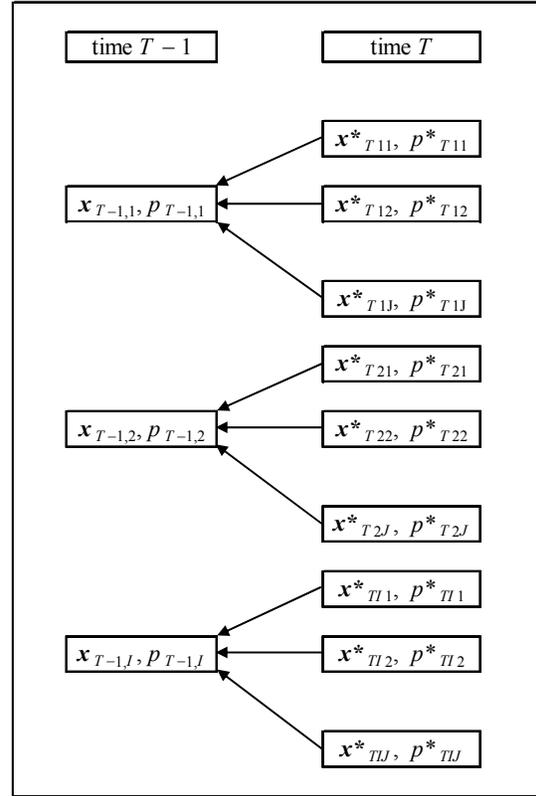

Figure 4b. Calculation of price at start of final year

Similarly, for each year from $T - 1$ to 2, we calculate the price of the liabilities at each node of the primary simulations. In these years, however, the price of the liabilities is known only for primary simulations, not for secondary simulations. As shown in Figure 5a, what we have at time t are secondary simulations of the state-space vector. As shown in Figure 5b, we also have the price of the liabilities at each node of the primary simulations at that time. What we need to do for each secondary simulation is to estimate a price corresponding to the state space simulated. Since the price depends only on the state-space vector, we may do this by selecting a nearby group of state-space vectors from the primary simulations and calculate a weighted average price—weighted, that is, by the relative nearness of each of the selected state-space vectors to the secondary state-space vector. The details of this process are described in Appendix B. Having estimated the year-end price corresponding to each secondary simulation of the state-space vector, we may then calculate the price at the start of the year as shown in Figure 5c. The details of the calculations are given in Appendix D.

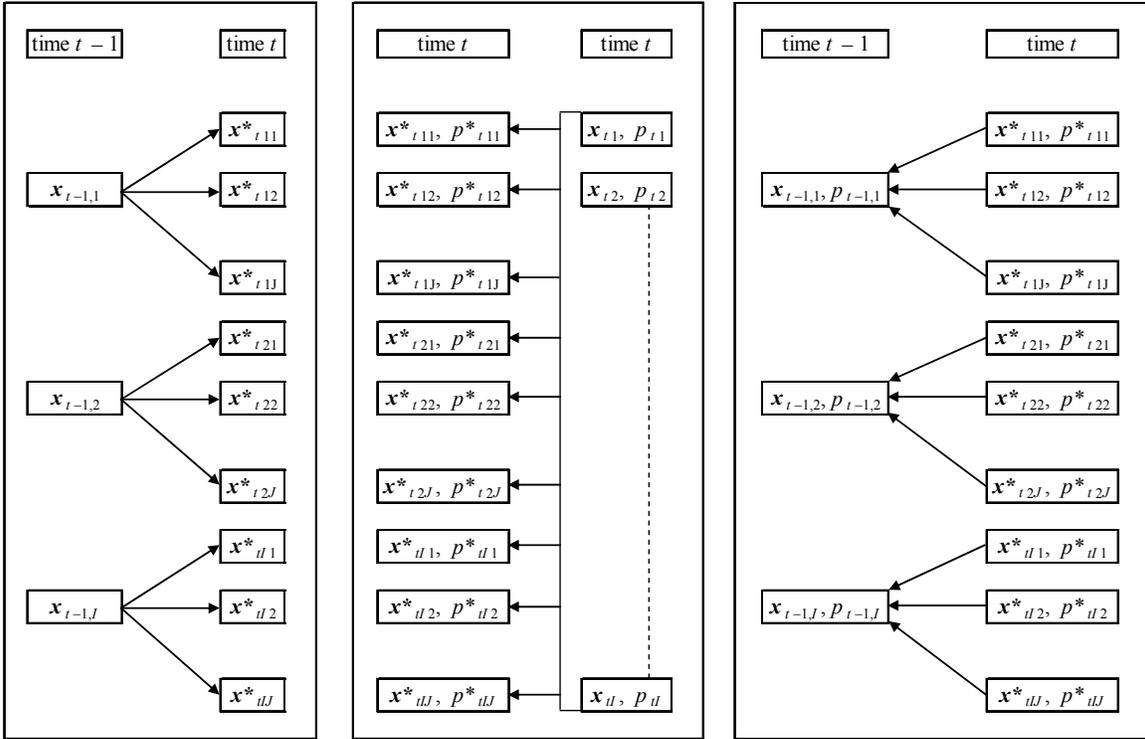

Figure 5. Secondary simulations:

Figure 5a.

Simulation of state space and prices at end of year t

Figure 5b.

Weighted average price corresponding to $x_{t,ij}^*$

Figure 5c.

Calculation of price at start of year t

For year 1 we follow the same process, except that in this case the state-space at the start of the year is known, so that, instead of repeating the calculations for each of a set of primary simulations, we arrive at a unique price p_0 as shown in Figure 6.

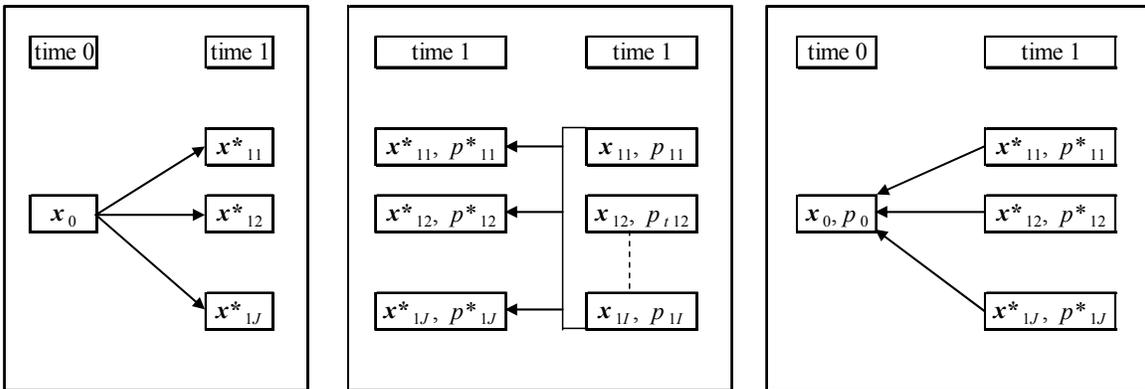

Figure 6. Secondary simulations:

Figure 6a.

Simulation of state space and prices at end of year t

Figure 6b.

Weighted average price corresponding to $x_{t,ij}^*$

Figure 6c.

Calculation of price at start of year t

The pricing algorithm is set out in Appendix E.

4.2 DEFINITION OF THE STATE-SPACE VECTOR

In practice it would assist in the interpolation process if the state-space vector were chosen so that the price of the liabilities is approximately linear in each component of that vector. For the purposes of this paper, the state-space vector was defined as:

$$\mathbf{x}_t = \begin{pmatrix} P_{It}(s_1) \\ \vdots \\ P_{It}(s_u) \\ P_{Ct}(s_1) \\ \vdots \\ P_{Ct}(s_u) \\ \theta_t \\ P_{x_t} \\ \vdots \\ P_{x_{Nt}} \end{pmatrix}; \quad (29)$$

where:

$$P_{It}(s) = \exp\{-Y_{It}(s)\}; \quad (30)$$

$$P_{Ct}(s) = \exp\{-Y_{Ct}(s)\}; \text{ and} \quad (31)$$

$$\theta_t = \exp(\chi_{vt}). \quad (32)$$

Here $P_I(s)$ and $P_C(s)$ represent the prices of index-linked and conventional bonds respectively and s_1, \dots, s_u represent selected terms to redemption. In order to reduce the dimensionality of the state-space vector, and therefore the computational demands of the algorithm, a subset of each yield curve is selected. θ_t represents the cumulative change in mortality. P_{x_t} represents the total accrued pensions of members in cohort n at time t , being of age x_n at that time.

4.3 ADJUSTING THE MODEL-POINT RESULTS

The pricing of the liabilities proceeds as follows. Let p denote the aggregate price of the liabilities for the model-point cohorts as described above. We find the deterministic value of the liabilities based on the fund data and the model-point data, which we denote by L_{FD} and L_{MD} respectively. For this purpose the value of the liability for member m aged x at time 0 is:

$$l_m = P_m \left\{ \frac{1}{2} + \exp\{-v_{\{x\}} - Y_{I0}(1)\} + \exp\{-v_{\{x\}} - v_{\{x+1\}} - Y_{I0}(2)\} + \dots \right\} \text{ for } x \geq R;$$

$$P_m \left\{ \frac{1}{2} \exp\{-v_{\{x\}} - Y_{I0}(1)\} + \exp\{-v_{\{x\}} - v_{\{x+1\}} - Y_{I0}(2)\} + \dots \right\} \text{ for } x = R;$$

$$P_m \exp\left\{ (R-x-1)\mu_{\xi} + \mu_{\zeta, x+1} + \dots + \mu_{\zeta, R-1} \right\}$$

$$\left. \begin{aligned} & \left\{ \frac{1}{2} \exp\{-Y_{I0}(R-x)\} + \exp\{-v_{\{x\}+R-x} - Y_{I0}(R-x+1)\} \right\} \text{ for } x < R \\ & \left\{ + \exp\{-v_{\{x\}+R-x} - v_{\{x\}+R-x+1} - Y_{I0}(R-x+2)\} + \dots \right\} \end{aligned} \right\} \quad (34)$$

Then:

$$L_{FD} = \sum_x \sum_{m \in G_{x1}^F} l_m ; \text{ and} \quad (35)$$

$$L_{MD} = \sum_x \sum_{m \in G_{x1}^M} l_m ; \quad (36)$$

where G_{x1}^F and G_{x1}^M are the sets of members aged x at the start of year 1 in the fund and in the model-point cohorts respectively.

The deterministic valuation produces a price that is equal to the stochastic valuation with all the random normal distributions set to their expected values. (Because of non-linearities, this does not mean that the resulting value is equal to the expected value of the stochastic price.)

Then the aggregate price of the liabilities is adjusted to allow for bias in the use of model points by multiplying the model-point price by the ratio of L_{FD} to L_{MD} to give the adjusted price:

$$\tilde{p} = p \frac{L_{FD}}{L_{MD}}. \quad (37)$$

4.4 ACCRUING COSTS

A similar exercise is undertaken for the liabilities currently accruing in respect of active members. The results represent the annual contributions currently required to fund the benefits on a basis consistent with the pricing of the accrued liabilities.

4.5 PROGRAMMING

The pricing algorithm was coded in R. The packages available in that language included a Sobol quasi-random multivariate normal number generator (Sobol, 1976). In order to expedite convergence, that generator was used instead of pseudo-random numbers. It was found better to generate a matrix of Sobol numbers for the primary simulations and a separate matrix for the secondary simulations, each of the dimensions required, and to access those matrices as and when required, than to generate the numbers as and when required.

The code is available from the author free of charge.

5. RESULTS

5.2 DETERMINISTIC VALUATION

On the basis of equations (35) and (36) it was found that the results of the deterministic valuations of accrued liabilities based on the fund data and the model-point data were:

$$L_{FD} = 2\,911\,803 ; \text{ and}$$

$$L_{MD} = 2\,930\,084 .$$

(As above, figures are in R'000.)

The values of the liabilities accruing per annum were:

$$L'_{FD} = 149\,749 ; \text{ and}$$

$$L'_{MD} = 150\,120 .$$

Based on the fund data, the deterministic cost of accruing liabilities was 22,96% of salaries.

5.3 STOCHASTIC PRICE

Using a single cohort (female members aged 55), convergence to three significant digits (i.e. about 0,1%) was achieved with the following values of the control parameters:

- the number of primary simulations: $I = 2000$;
- the number of secondary simulations: $J = 250$;
- the selected terms to redemption (cf. section 4.2): 1, 5, 10, 15 and 20 years for index-linked bonds and 1, 5, 10 and 20 years for conventional bonds;
- the number of primary simulations selected for weighted averaging (cf. Appendix B): $E = 700$; and
- the power of the dispersion measure for averaging (cf. Appendix B): $n = 2$.

The program was run with an Intel C2 Quad CPU at 2,33GHz. Using the above control parameters for all cohorts combined, the determination of the accrued liabilities took 47 hours. Slightly better convergence was achieved using larger values of I and J but the accuracy required for this paper did not justify the extra run time.

On the basis proposed in this paper, the price of the accrued model-point liabilities is:

$$p = 3\,063\,000.$$

Adjusted to correspond to the fund data, this gives:

$$\tilde{p} = 3\,044\,000.$$

Overall, the stochastic price exceeds the deterministic value by 4,5%. (As above, figures are in R'000.)

The price of the accruing model-point liabilities is:

$$p' = 165\,820.$$

Adjusted to correspond to the fund data, this gives:

$$\tilde{p}' = 165\,410;$$

that is 25,4% of total salaries. Overall, the stochastic price exceeds the deterministic value by 10,5%.

As explained in Thomson (2005), the price of the liabilities is not additive. In the first place, there is intra-cohort non-additivity. This effect may be shown by determining the price of the liabilities per unit of accrued pension for each cohort separately. This may be done for all members in the cohort and for a single member in that cohort (i.e. by setting $M_{xt} = 1$). Inter-cohort non-additivity may be shown by comparing the price of the liabilities for all cohorts combined with the sum of the prices of the liabilities for the cohorts. These effects are shown in Table 2, which analyses the price of the accrued liabilities in comparison with the deterministic valuation. In the row captioned 'Adjusted' the values have been adjusted to correspond to the fund data. 'Total' means an arithmetic total of the relevant values shown. '% incr' shows the percentage change between the preceding two columns.

At active ages the excess of the stochastic price as shown in column (2) over the deterministic value of the liabilities as shown in column (1) is essentially due to the cost of the guarantee that, when inflation is negative, nominal pensions will not be reduced. (The increase is shown in column (3).) The effect of the guarantee decreases with attained

age: for older members the funnel of doubt about future inflation rates does not widen as much as for younger members. For the latter members the reduction in price due to the risk premium included in the effective discount rate predominates. As anticipated in section 1, this effect is relatively small.

Table 2. Analysis of price of accrued liabilities

Sex	Age	Value per unit accrued pension					Aggregate value		
		deterministic valuation	stochastic price			deterministic valuation	stochastic price		
			1 member		entire cohort				
			% incr		% incr		R'million		% incr
		(1)	(2)	(3)	(4)	(5)	(6)	(7)	(8)
Female									
	25	14,11	16,40	16,2	16,25	-0,9	17	19	15,2
	35	11,94	13,79	15,5	13,70	-0,7	172	198	14,7
	45	12,00	13,81	15,1	13,72	-0,6	311	356	14,3
	55	12,67	13,96	10,2	13,88	-0,5	347	380	9,6
	65	13,36	13,41	0,4	13,41	0,0	434	435	0,4
	75	9,53	9,25	-2,9	9,25	0,0	236	229	-2,9
	85	5,96	5,53	-7,2	5,53	0,0	62	58	-7,2
	total						1 579	1 675	6,1
Male									
	25	12,27	14,05	14,5	13,92	-0,9	15	17	13,4
	35	10,35	11,77	13,8	11,69	-0,7	149	169	13,0
	45	10,37	11,75	13,3	11,67	-0,6	269	303	12,6
	55	10,89	11,83	8,7	11,77	-0,5	298	322	8,1
	65	11,38	11,26	-1,1	11,26	0,0	369	366	-1,1
	75	7,95	7,60	-4,3	7,60	0,0	196	188	-4,3
	85	5,25	4,80	-8,5	4,80	0,0	55	50	-8,5
	total						1 351	1 414	4,6
Total							2 930	3 088	5,4
Aggregate							2 930	3 063	4,5
Adjusted to fund data							2 912	2 912	4,5

The effects of intra-cohort non-additivity are relatively small. As shown in column (5), they apply only at active ages. This is because, as explained in section 2.1, individual pensioner mortality risks are diversifiable. Risks relating to improvement in mortality and pension increases are proportionate to the liabilities, and liabilities for pensioners are therefore additive.

The total increase in the price of the liabilities (column (7)) over the deterministic valuation (column (6)) is shown in column (8). Because of their greater longevity, female members show a greater increase. Again, this is essentially due to the cost of the guarantee for longer time horizons. As shown in column (7), the aggregate stochastic price of the model-point liabilities is R3 063 million, 0,82% less than the total of those liabilities. This reduction is due to inter-cohort non-additivity.

Without the guarantee on the pension increase, the stochastic price of the liabilities reduces from R3 063 million to R2 874 million, i.e. by 6,17%. The latter price, in turn, is 1,9% less than the deterministic valuation of R2 930 million. This represents the

aggregate reduction in price due to the risk premium included in the effective discount rate.

5.4 SENSITIVITY TESTS

The results of sensitivity tests of the aggregate stochastic price are reported in Table 3. For the purposes of these tests, only those parameters that do not enter into the deterministic valuation are considered; in general, the sensitivity to parameters of the deterministic valuation will be similar to the sensitivity of the deterministic valuation to those parameters. Because of their complexity, the parameter sets $b_{I,1}(s)$ and $b_{I,2}(s)$, representing the sensitivity of the return on an s -year index-linked bond to the factor driving the return on a 1-year and 20-year bond respectively, and the corresponding sets $b_{C,1}(s)$ and $b_{C,2}(s)$ for conventional bonds, have not been considered. For the same reason, the parameter set a_{ij} , representing the composition of the i th factor in terms of notional risky asset j has not been considered. It is not expected that the effects of feasible changes in these parameters would be substantial. In some cases, groups of parameters are considered together. The results are reported in terms of the model-point data; no adjustment has been made for the fund data.

While the test values have been subjectively chosen, the intention is to reflect the feasible range from a minimum possible absolute value to the value adopted. In the cases of certain volatilities zero values were not used as they would have resulted in anomalies in the calculations.

An opposite range in terms of increase in absolute value would be equally feasible, and for the purposes of discussion it is assumed that, in absolute value, the effect on the price of the liabilities would be similar.

The most substantial effect is for b_γ , the volatility of the force of inflation in excess of conditional ex-ante expected inflation (parameter set 8). A reduction in this volatility reduces the price of the guarantee that, when inflation is negative, nominal pensions will not be reduced. Clearly the volatility will not reduce to zero, so that the uncertainty is considerably less than 1%.

The effects of g and σ_M (parameter sets 6 and 7) are also substantial. The former is the sensitivity of ex-ante expected returns on the market portfolio to positive risk-free returns and the latter is the residual volatility of the return on the market portfolio. In the estimation of these parameters in Thomson (unpublished b), the minimum 'required' value of g was 1,2. In the calibration of the descriptive model of the market portfolio, the confidence limits embraced lower values. However, it is argued in that paper that such values would not be consistent with risk-aversion. Nevertheless, as discussed in Thomson (*ibid.*) there is considerable scope for subjectivity in the setting of g for the purposes of predictive modelling, so, ex ante, the upside range may be greater than the downside range. The confidence limits of σ_M were (0,11; 0,20), so that the range contemplated is reasonable. The explanation of these effects requires further analysis.

b_{ξ_1} , the sensitivity to inflation of the general salary increase, slightly affects the price, as it affects the cost of the pension guarantee.

Table 3. Sensitivity of the aggregate stochastic price to the parameters

Parameter					Test result (R'million)	
set	name	description	standard value	test value	price (R'million)	change in price
0		standard values			3 063	N/A
1	b_{ξ_1}	general salary increase: sensitivity to inflation	-0,005	0	3 067	0,14
2	b_{ξ_2}	general salary increase: sensitivity to return on market portfolio	0,005	0	3 063	-0,01
3	σ_{ξ}	general salary increase: residual volatility	0,03	0,01	3 063	0,01
4	$\alpha_{\sigma_{\xi}}$	volatility of additional increase: level parameter	0,042	0	3 064	0,01
	$\beta_{\sigma_{\xi}}$	volatility of additional increase: slope parameter	0,5	0		
	$\lambda_{\sigma_{\xi}}$	volatility of additional increase: age parameter	0,08	0		
5	b_v	pensioner mortality: sensitivity to return on market portfolio	-0,001	0	3 063	0,01
	σ_v	pensioner mortality: residual volatility	0,005	0,001		
6	g	return on market portfolio: sensitivity to risk-free rate	1,39	1,2	3 052	-0,37
7	σ_M	return on market portfolio: residual volatility	0,159	0,1	3 077	0,45
8	b_{γ}	force of inflation: residual volatility	-0,01379	0	3 030	-1,07
9	ϕ	inflation risk premium	0,003	0	3 063	0,00
10	b_{E1}	return on equities: residual volatility	0,13923	0,1	3 063	0,00

The effects of the remaining parameters are insubstantial. For the sake of simplicity they could be omitted from the formulation. It should be noted, though, that this is a large fund. For a smaller fund the relative effects of the additional salary increases (parameter set 4) may be more substantial than for this fund.

Overall it appears from the above analysis that the uncertainty of the price is less than 1%.

6. CONCLUSION

While every effort has been made by the author to ensure the correctness of the results reported in this paper, the program has not yet been independently checked. Before submitting the paper for publication, the author intends to engage a co-author to check the program in detail and share responsibility for the findings. In the mean time the findings should be regarded as provisional.

For the purposes of this paper, the TGESA2 equilibrium model was used. That model is similar to the TGESA1 model. As shown in Thomson & Gott (unpublished), the TGESA1 model tends to include quite substantial negative inflation rates, and negative yields on index-linked bonds in the long-term future. While this problem is mitigated in the TGEUK1 model, the use of a similar South African model for the purposes of this paper gave rise to some anomalies. The further development of a South African equilibrium model is a matter for further research.

Despite the fact that the deterministic value of the liabilities was determined at risk-free index-linked bond yields, the stochastic price of the liabilities was found to be 4,5% higher. This was essentially due to the cost of the guarantee that, when inflation is negative, nominal pensions will not be reduced. In view of the problems mentioned in the preceding paragraph, the cost of this guarantee is arguably overstated in this paper.

Without that guarantee, the price of the liabilities is only 1,9% less than the deterministic value. As explained in section 1, the risk-premium effect shown here is a considerably smaller departure from the value based on risk-free bond yields than that produced by the risk premiums typically used in deterministic valuations. If it is accepted that the valuation of the liabilities should allow for a risk premium only to the extent that the trustees are unable to avoid risk, then it is apparent that the valuation basis must be much closer to a risk-free basis than that produced by the risk premiums typically used.

On the other hand, if that is not accepted, it must be questioned what the role of the trustees is. From the members' point of view their function would then constitute an agency problem in that, with adequate expertise at no extra cost, the members would be better advised to make their own arrangements for their retirement benefits in respect of future service; the trustees' function would merely be serving to reduce the security of the members.

While the effects of non-additivity are noticeable even with only three significant digits of accuracy, they are relatively minor. Intra-cohort non-additivity reduces the price of the liabilities by 0 to 0,9%, while inter-cohort non-additivity reduces it by a further 0,82%.

As regards sensitivity, the most substantial effect is for b_γ , the volatility of the force of inflation in excess of conditional ex-ante expected inflation. The effects of g and σ_M are also substantial. The former is the sensitivity of ex-ante expected returns on the market portfolio to positive risk-free returns and the latter is the residual volatility of the return on the market portfolio. The reasons for these effects require further analysis. b_{ξ_1} , the sensitivity to inflation of the general salary increase, slightly affects the price, as it affects the cost of the pension guarantee. The effects of the remaining parameters are insubstantial. For the sake of simplicity, but subject to certain caveats, they could be omitted from the formulation.

Overall, the sensitivity of the price of the liabilities to the parameters of the model is considerably less than the error involved in a deterministic valuation. In broad terms, an error of the order of 4,5% (for accrued liabilities) to 10,5% (for accruing liabilities) is reduced to uncertainty of the order of 1%. As explained in section 5.4, this excludes uncertainty common to both approaches. In comparison with the use of bond yields plus a risk premium, the error—and hence the improvement—is substantially greater.

In this paper, no consideration has been given to constraints on the market portfolio or on the fund's investment portfolio. The latter would constitute an appropriate benchmark for the establishment of investment policy and the measurement of investment performance. In practice, both are subject to a minimum of zero for each asset category and, in the case of bonds, for each term to redemption. In addition, the fund's investment portfolio is subject to the requirements of regulation 28 under the Pension Funds Act. In terms of that regulation, the maximum that may be invested in equities is 75% of the fund's assets. The application of these constraints requires further work both on the equilibrium model and on the pricing algorithm.

It would also be of interest to compare the results of this paper with corresponding stochastic results based on fair value, i.e. the price of the liabilities assuming that a complete market existed. This would entail the pricing of the liabilities with no allowance for the risk premium due to the residual risks. These comprise the risks that cannot be fully diversified (*viz.* the risks of salary increases and improvement in pensioner mortality) and those that cannot be hedged by means of mean-variance hedging. An analysis of these effects awaits further research.

The methods of this paper may be applied to the funding of the benefits of individual members in a defined-contribution fund, with prospective benefits expressed in terms of pensions based on final salary and length of service. Similar methods could be used for lump sums if and to the extent that they are considered preferable. For these purposes, additional information may be available regarding the prospects of an individual member with regard to future salary increases and post-retirement mortality, with possible reduction in uncertainty and therefore in risk premium. If necessary, any balance of the cost of benefits may be met by additional contributions by employees (or, equivalently, by the employer on behalf of individual employees). The trustees may arrange for advice to be given to members regarding reasonable benefit expectations, additional contribution rates required, investment channel selection and the risks to be borne by the member, the fund, the employer and any underwriter. For these purposes it would be necessary to fund the full price of the liabilities for each member, without any reduction for non-additivity. This would provide a flexible framework for the funding of benefits for members that would facilitate a compromise between defined contributions and defined benefits so as to retain the advantages of both systems as perceived by employees and employers.

Essentially, though, subject to the caveats mentioned above, this paper serves to operationalise the pricing of defined-benefit liabilities in an incomplete market. The attainment of certainty in the pricing of such liabilities belongs to another world: that of the Holy Grail or the rainbow's end. In a world veiled by uncertainty the best we can do is to roll back that veil so far as we are able.

ACKNOWLEDGEMENTS

The author acknowledges with thanks the work of Mr Steven Kransdorff, a former honours student who devoted his research to the topic of this paper. In the final stages of this research it was necessary to use 50 computers, running concurrently, to test convergence and produce the results required; thanks go to Mr Shunmuga Pillay for arranging this. Thanks also go to Mr Arthur Els, who supplied the fund data on which the

illustrative calculations were based. The financial assistance of the Actuarial Society of South Africa is acknowledged. Opinions expressed and conclusions drawn are those of the author and are not to be attributed to the Society.

REFERENCES

- Benjamin, B. & Pollard, J.H. (1980). *The Analysis of Mortality and Other Actuarial Statistics*. 2nd ed. Heinemann, London, for the Institute of Actuaries and the Faculty of Actuaries
- Dorrington, R.E. & Tootla, S. (2007). South African annuitant standard mortality tables 1996–2000 (SAIML98 and SAIFL98), *South African Actuarial Journal* **7**, 161–84
- CMI (2006). The Graduation of the CMI 1999-2002 Mortality Experience: Final "00" Series Mortality Tables, working paper 22, Continuous Mortality Investigation Mortality Committee, Faculty and Institute of Actuaries, www.actuaries.org.uk/data/assets/pdf_file/0014/20174/wp22.pdf
- Exley, C.J., Mehta, S.J.B. & Smith, A.D. (1997). The financial theory of defined benefit pension schemes. *British Actuarial Journal* **3(4)**, 835–966
- Head, S.J., Adkins, D.R., Cairns, A.J.G, Corvesor, A.J., Cule, D.O., Exley, C.J., Johnson, I.S., Spain, J.G. & Wise, A.J. (2000). Pension fund valuations and market values. *British Actuarial Journal* **6(1)**, 143–213
- Sobol, I.M. (1976). Uniformly distributed sequences with additional uniformity properties. *USSR Computational Mathematics and Mathematical Physics* **16(5)**, 236–42
- Thomson, R.J. (2002). Editorial. *South African Actuarial Journal* **2**, 147–50
- Thomson, R.J. (2005). The pricing of liabilities in an incomplete market using dynamic mean–variance hedging. *Insurance: Mathematics and Economics* **36**, 441–55
- Thomson, R.J. (unpublished a). Modelling the market in a risk-averse world, 18th International AFIR Colloquium, 2008, www.actuaries.org/AFIR/Colloquia/Rome2/papers.cfm
- Thomson, R.J. (unpublished b). Modelling the market in a risk-averse world: the case of South Africa, convention of the Actuarial Society of South Africa, 23 October 2008, www.africanagenda.com/convention2008registration/papers.php
- Thomson, R.J. & Gott, D.V. (unpublished). Stochastic models for actuarial use: the equilibrium modelling of local markets, convention of the Actuarial Society of South Africa, 12 October 2006, www.actuarialsociety.org.za/Resource-Centre/Papers-Conventions-and-Sessional-Meetings/Convention-Papers-2006-169.aspx
- Thomson, R.J. & Gott, D.V. (forthcoming). Stochastic models for actuarial use: the equilibrium modelling of local markets, forthcoming in *ASTIN Bulletin*

GLOSSARY OF RELATED MODELS

Model	Reference	Description	Comment
General			
TP1	Thomson (2005)	pricing model for an incomplete market using the CAPM with mean–variance hedging	includes a weighted averaging algorithm for price estimation and a stochastic DB liabilities model; illustrative application to SA
TP2	this paper		
South African models			
TGMSA1	Thomson & Gott (unpublished)	tentative model of the market portfolio	incorporated in TGESA1
TGESA1		equilibrium model	
TMSA2	Thomson (unpublished b)	predictive model of the market portfolio	
TMSA3	this paper	amended model of the market portfolio	incorporated in TGESA2
TGESA2		amended version of TGESA1	
UK models			
TGMUK1	Thomson & Gott (forthcoming)	tentative model of the market portfolio	incorporated in TGEUK1
TGEUK1		equilibrium model	
TMUK2	Thomson (unpublished a)	predictive model of the market portfolio	

APPENDIX A
TABULATION OF DATA AND MORTALITY ASSUMPTIONS

Tables A.1 and A.2 show the fund data for active members and pensioners respectively. Table A.3 shows the rate of pensioner mortality $\mu_{\{x\}}^{SAP98}$ for the year of age x in 1998.

Table A.1. Fund data

Age	No. of members	Pensions accruing p.a. (R'000)	Accrued pension (R'000)	Age	No. of members	Pensions accruing p.a. (R'000)	Accrued pension (R'000)
21	2	4	2	43	206	434	5062
22	9	14	12	44	208	434	5234
23	16	24	36	45	210	438	5460
24	23	36	72	46	207	426	5500
25	30	50	124	47	204	416	5534
26	46	80	246	48	201	406	5562
27	62	110	408	49	198	396	5584
28	78	144	618	50	195	386	5598
29	94	180	876	51	192	376	5608
30	110	214	1174	52	189	368	5610
31	126	250	1522	53	186	358	5606
32	142	288	1922	54	183	348	5598
33	158	322	2352	55	180	336	5524
34	174	358	2832	56	176	324	5440
35	190	396	3360	57	172	314	5352
36	192	404	3588	58	168	302	5262
37	194	412	3824	59	164	290	5108
38	196	416	4030	60	160	278	5012
39	198	420	4240	61	156	268	4910
40	200	424	4452	62	152	256	4750
41	202	428	4668	63	148	246	4644
42	204	428	4840	64	146	240	4598

Table A.2. Fund data: pensioners

Age	No. of pensioners	Pension (R'000)	Age	No. of pensioners	Pension (R'000)	Age	No. of pensioners	Pension (R'000)
65	143	4490	78	83	1788	91	20	286
66	140	4368	79	77	1619	92	16	231
67	136	4123	80	72	1459	93	13	185
68	132	3882	81	66	1307	94	11	145
69	128	3645	82	61	1165	95	9	112
70	124	3413	83	55	1031	96	7	85
71	119	3186	84	50	907	97	5	63
72	114	2965	85	45	791	98	4	45
73	109	2751	86	40	684	99	3	32
74	104	2543	87	36	587	100	2	22
75	99	2343	88	31	498	101	1	15
76	93	2150	89	27	419	102	1	10
77	88	1965	90	23	348	103	1	6

Table A.3. Pensioner mortality

Age		$\mu_{\{x\}}^{SAP98}$		Age		$\mu_{\{x\}}^{SAP98}$	
x	female	male	x	female	male		
60	0,00917	0,01493	86	0,10538	0,14148		
61	0,01070	0,01773	87	0,11545	0,15041		
62	0,01239	0,02087	88	0,12655	0,15960		
63	0,01422	0,02429	89	0,13884	0,16970		
64	0,01614	0,02799	90	0,15240	0,18211		
65	0,01822	0,03115	91	0,16713	0,19511		
66	0,02052	0,03374	92	0,18344	0,20852		
67	0,02292	0,03655	93	0,20159	0,22232		
68	0,02541	0,03958	94	0,22184	0,23646		
69	0,02786	0,04282	95	0,24447	0,25090		
70	0,03027	0,04624	96	0,26980	0,26559		
71	0,03276	0,04981	97	0,29847	0,28235		
72	0,03533	0,05360	98	0,32920	0,30105		
73	0,03802	0,05771	99	0,36123	0,31986		
74	0,04085	0,06212	100	0,38826	0,34440		
75	0,04384	0,06684	101	0,41120	0,37627		
76	0,04705	0,07186	102	0,43665	0,41084		
77	0,05052	0,07718	103	0,46258	0,44831		
78	0,05432	0,08281	104	0,48965	0,48888		
79	0,05849	0,08878	105	0,51902	0,53281		
80	0,06312	0,09509	106	0,55063	0,58032		
81	0,06828	0,10177	107	0,58445	0,63170		
82	0,07407	0,10883	108	0,62046	0,68725		
83	0,08057	0,11633	109	0,65866	0,74734		
84	0,08793	0,12432	110	0,69910	0,81231		
85	0,09625	0,13278	111	∞	∞		

APPENDIX B
SECONDARY SIMULATION:
ESTIMATION OF PRICE AT END OF YEAR

In the primary simulations of the state space, we have simulated at time t the state-space matrix:

$$\mathbf{X}^* = (\mathbf{x}_1^* \quad \dots \quad \mathbf{x}_I^*); \quad (\text{B1})$$

where:

$$\mathbf{x}_i^* = \begin{pmatrix} x_{1i}^* \\ \vdots \\ x_{Di}^* \end{pmatrix}; \quad (\text{B2})$$

and x_{di} is the d th component of the i th simulation, for $d=1, \dots, D$ and $i=1, \dots, I$. (For simplicity, the subscript t is suppressed.)

In the secondary simulations, prices at time t have been determined from the primary simulations and from secondary simulations of the state space at later times. (As indicated in section 4.1, the secondary simulations proceed in reverse for $t = T, T-1, \dots, 1$.) We denote these prices:

$$\mathbf{p}^* = \begin{pmatrix} p_1^* \\ \vdots \\ p_I^* \end{pmatrix}; \quad (\text{B3})$$

where p_i^* is determined from the i th primary simulation.

In the secondary simulation we simulate the state space at time t , viz.:

$$\mathbf{x}_j = \begin{pmatrix} x_{1j} \\ \vdots \\ x_{Dj} \end{pmatrix}; \quad (\text{B4})$$

where x_{dj} is the d th component of the j th secondary simulation.

From this information we need to estimate p_j , the price at time t corresponding to the j th secondary simulation. First we select a set of columns of \mathbf{X}^* as follows. We determine a weighting vector:

$$\mathbf{w}_j = \begin{pmatrix} w_{1j} \\ \vdots \\ w_{Ij} \end{pmatrix};$$

where:

$$w_{ij} = \frac{1}{\sum_{d=1}^D \frac{r_d}{s_d^{(n)}} |x_{dj} - x_{di}^*|^n} \quad \text{for } i=1, \dots, I; \quad (\text{B5})$$

$$s_d^{(n)} = \frac{1}{I-1} \sum_{i=1}^I |x_{di}^* - \bar{x}_d^*|^n; \quad (\text{B6})$$

$$\begin{pmatrix} r_1 \\ \vdots \\ r_D \end{pmatrix} = \mathbf{R}^{-1} \mathbf{1}; \quad (\text{B7})$$

$$\mathbf{R} = \begin{pmatrix} 1,001 & \hat{\rho}_{12} & \cdots & \hat{\rho}_{1D} \\ \hat{\rho}_{21} & 1,001 & \cdots & \hat{\rho}_{2D} \\ \vdots & \vdots & \ddots & \vdots \\ \hat{\rho}_{D1} & \hat{\rho}_{D2} & \cdots & 1,001 \end{pmatrix}; \quad (\text{B8})$$

$\mathbf{1}$ is the unit vector of length D ;

$$\hat{\rho}_{d_1 d_2} = \frac{s_{d_1 d_2}^{(2)}}{\sqrt{s_{d_1}^{(2)} s_{d_2}^{(2)}}} \quad (\text{B9})$$

$$s_{d_1 d_2}^{(2)} = \frac{1}{I-1} \sum_{i=1}^I (x_{d_1 i}^* - \bar{x}_{d_1}^*) (x_{d_2 i}^* - \bar{x}_{d_2}^*); \text{ and} \quad (\text{B10})$$

$$\bar{x}_d^* = \frac{1}{I} \sum_{i=1}^I x_{di}^*. \quad (\text{B11})$$

In (B5) the power n is an integer chosen so as to optimise convergence: too small a value will tend to place excessive emphasis on more distant points in the state space and result in bias, while too large a value will ignore the available details of the price hypersurface. $s_d^{(n)}$ is a dispersion factor for the d th dimension with the same power, which, in (B5), offsets the scale of $\{x_{di} | i = 1, \dots, I\}$.

r_d is an adjustment to compensate for correlation between x_{di}^* and other components of \mathbf{x}_i^* . In \mathbf{R} the diagonal of the estimated correlation matrix has been increased by a small margin to avoid singular matrices. For example, suppose that, for a particular year of the primary simulations:

$$\mathbf{R} = \begin{pmatrix} 1,001 & 1 & 0 \\ 1 & 1,001 & 0 \\ 0 & 0 & 1,001 \end{pmatrix}.$$

This might, for example, occur for components 1 and 2 being those of index-linked bonds close to maturity and for component 3 being an accrued pension. Then:

$$\begin{aligned} \begin{pmatrix} r_1 \\ r_2 \\ r_3 \end{pmatrix} &= \begin{pmatrix} 500,25 & -499,75 & 0 \\ -499,74 & 500,25 & 0 \\ 0 & 0 & 0,999 \end{pmatrix} \begin{pmatrix} 1 \\ 1 \\ 1 \end{pmatrix} \\ &= \begin{pmatrix} 0,500 \\ 0,500 \\ 0,999 \end{pmatrix}. \end{aligned}$$

But for the increase in the diagonal, the adjustment to components 1 and 2 would have been indeterminate. With the increase they are each halved, which, by symmetry, is appropriate. The weighting of component 3 remains approximately unadjusted.

We then select the E columns of \mathbf{X}^* corresponding to the E greatest values of w_i , where E is chosen so as to optimise convergence: too large a value will tend to place excessive emphasis on more distant points, which will result in errors due to non-linearity, while too small a value will ignore the available details. We define the matrix:

$$\tilde{\mathbf{X}}_j = (\tilde{\mathbf{x}}_1^* \quad \cdots \quad \tilde{\mathbf{x}}_E^*). \quad (\text{B12})$$

where the set $\{\tilde{\mathbf{x}}_1^*, \dots, \tilde{\mathbf{x}}_E^*\}$ comprises those columns. Let

$$\tilde{\mathbf{p}}_j = \begin{pmatrix} \tilde{p}_1 \\ \vdots \\ \tilde{p}_E \end{pmatrix} \quad (\text{B13})$$

denote the prices selected from the corresponding components (i.e. the corresponding primary simulation nodes) of \mathbf{p}^* and let

$$\tilde{\mathbf{w}}_j = \begin{pmatrix} \tilde{w}_1 \\ \vdots \\ \tilde{w}_E \end{pmatrix} \quad (\text{B14})$$

denote the weightings selected from the corresponding components of \mathbf{w}_j . Then we estimate p_j as the weighted mean of the selected components of $\tilde{\mathbf{p}}_j$, viz.:

$$p_j = \frac{\tilde{\mathbf{w}}_j' \tilde{\mathbf{p}}_j}{\tilde{\mathbf{w}}_j' \mathbf{1}}; \quad (\text{B15})$$

where $\mathbf{1}$ is the unit vector of length E .

APPENDIX C MARKET EQUILIBRIUM MODEL TGESA2

C.1 As stated above, the parameters required for the equilibrium model are as follows:

for all required values of s :

$$Y_{I0}(s) = sy_I(s) \text{ and } Y_{C0}(s) = sy_C(s);$$

where $y_I(s)$ and $y_C(s)$ are the yields to redemption on s -year zero-coupon index-linked and conventional bonds respectively, at the valuation date; and

$$b_{Ij}(s) \text{ and } b_{Cj}(s) \text{ for } j = 1, 2;$$

- b_γ ; and
- b_{E1} ;

for $i = 1, \dots, N$ and $j = 1, \dots, 6$:

- a_{ij} ;

and:

- ϕ .

C.2 The parameters required for the equilibrium model are as follows:

- σ_M ; and
- g .

C.3 From the above values we have:

$$\delta_{I1}(0) = Y_{I0}(1); \tag{C1}$$

$$\sigma_{IM}(s) = -\sigma_M \{b_{I1}(s) + b_{I2}(s)\}; \tag{C2}$$

$$\sigma_{CM}(s) = -\sigma_M \{b_\gamma + b_{C1}(s) + b_{C2}(s)\}; \text{ and} \tag{C3}$$

$$\sigma_{EM} = b_{E1} \sigma_M. \tag{C4}$$

C.4 For $t = 1$ we then determine:

$$\begin{aligned} \mu_{Mt} &= g\delta_{It}(0) \text{ if } \delta_{It}(0) > 0; \\ &= \delta_{It}(0) \text{ otherwise.} \end{aligned} \tag{C5}$$

C.5 Using Monte Carlo methods we then select Sobol quasi-random standard normal variables:

$$\varepsilon_{it} \text{ for } i = 1, \dots, N. \tag{C6}$$

C.6 From the above values we calculate:

$$k_t = \frac{\mu_{Mt} - \delta_{It}(0)}{\sigma_M^2}; \quad (\text{C7})$$

$$\eta_{jt} = \sum_{i=1}^N a_{ij} \varepsilon_{it}; \quad (\text{C8})$$

$$\mu_{\gamma t} = Y_{C,t-1}(1) - Y_{I,t-1}(1) - \phi; \quad (\text{C9})$$

$$\gamma_t = \mu_{\gamma t} + b_{\gamma} \eta_{3t}; \quad (\text{C10})$$

$$\mu_{It}(s) = \delta_{It}(0) + k_t \sigma_{IM}(s); \quad (\text{C11})$$

$$\mu_{Ct}(s) = \delta_{It}(0) + k_t \sigma_{CM}(s); \quad (\text{C12})$$

$$\mu_{Et} = \delta_{It}(0) + k_t \sigma_{EM}; \quad (\text{C13})$$

$$\delta_{It}(s) = \mu_{It}(s) - b_{I1}(s) \eta_{1t} - b_{I2}(s) \eta_{2t}; \quad (\text{C14})$$

$$\delta_{Ct}(s) = \mu_{Ct}(s) - b_{\gamma} \eta_{3t} - b_{C1}(s) \eta_{4t} - b_{C2}(s) \eta_{5t}; \quad (\text{C15})$$

$$\delta_{Et} = \mu_{Et} + b_{E1} \eta_{6t}; \quad (\text{C16})$$

$$Y_{It}(\tau) = 2Y_{I,t-1}(\tau) - Y_{I,t-1}(\tau-1) - \delta_{It}(\tau); \quad (\text{C17})$$

$$Y_{It}(s) = Y_{I,t-1}(s+1) - \delta_{It}(s); \quad (\text{C18})$$

$$Y_{Ct}(\tau) = 2Y_{C,t-1}(\tau) - Y_{C,t-1}(\tau-1) - \gamma_t - \delta_{Ct}(\tau); \text{ and } \quad (\text{C19})$$

$$Y_{Ct}(s) = Y_{C,t-1}(s+1) - \gamma_t - \delta_{Ct}(s). \quad (\text{C20})$$

Finally, for $t < T$, we set:

$$\delta_{I,t+1}(0) = Y_{It}(1). \quad (\text{C21})$$

C.7 The calculations in ¶¶C.4–6 are repeated for $t = 2, \dots, T$.

APPENDIX D
DETERMINATION OF THE PRICE OF LIABILITIES
AT THE START OF A YEAR

In this appendix, which follows Thomson (2005), the derivation of the price at the start of year t is set out. As there explained, this method is based on mean–variance hedging and the equilibrium assumptions of the CAPM. It is assumed that the following variables have been determined:

- F_{tj} , i.e. the price of the liabilities at the end of year t , including cash flows then due, for each secondary simulation $j = 1, \dots, J$;
- $f_t = \exp\{\delta_{lt}(0)\}$; and
- $\mathbf{V}_{tj} = \begin{pmatrix} V_{1tj} \\ \vdots \\ V_{Ntj} \end{pmatrix}$;

where V_{ntj} is the market value at time t of an investment in asset category $n = 1, \dots, N$ per unit investment at time $t - 1$ for each secondary simulation j .

Then we calculate $P_{L,t-1}$, the price of the liabilities at the start of the year, as follows:

$$\hat{\mu}_{Ft} = \frac{1}{J} \sum_{j=1}^J F_{tj}; \quad (D1)$$

$$\hat{\mu}_{Vt} = \frac{1}{J} \sum_{j=1}^J V_{tj}; \quad (D2)$$

$$\hat{\sigma}_{Ft}^2 = \frac{1}{J-1} \sum_{j=1}^J (F_{tj} - \hat{\mu}_{Ft})^2; \quad (D3)$$

$$\hat{\sigma}_{FVt} = \frac{1}{J-1} \sum_{j=1}^J (F_{tj} - \hat{\mu}_{Ft})(V_{tj} - \hat{\mu}_{Vt}); \quad (D4)$$

$$\hat{\Sigma}_{Vt} = \frac{1}{J-1} \sum_{j=1}^J (\mathbf{V}_{tj} - \hat{\mu}_{Vt}) \otimes (\mathbf{V}_{tj} - \hat{\mu}_{Vt})'; \quad (D5)$$

where \otimes denotes the Kronecker product, i.e.:

$$[a_i] \otimes [b_i]' = [a_i b_i];$$

$$\hat{\sigma}_{\varepsilon t}^2 = \hat{\sigma}_{Ft}^2 - \hat{\sigma}'_{FVt} \hat{\Sigma}_{Vt}^{-1} \hat{\sigma}_{FVt}; \quad (D6)$$

$$\mathbf{z}_t = \hat{\Sigma}_{Vt}^{-1} (\hat{\mu}_{Vt} - f_t \mathbf{1}) \quad (D7)$$

$$\mathbf{m}_t = \frac{1}{\mathbf{z}_t' \mathbf{1}} \mathbf{z}_t; \quad (D8)$$

$$\hat{\mu}_{Mt} = \mathbf{m}_t' \hat{\mu}_{Vt}; \quad (D9)$$

$$\hat{\sigma}_{Mt}^2 = \mathbf{m}_t' \hat{\Sigma}_{Vt} \mathbf{m}_t; \quad (D10)$$

$$\hat{\sigma}_{HMt} = \mathbf{m}_t' \hat{\sigma}_{FVt}; \quad (D11)$$

$$\hat{\beta}_{Ft}^* = \frac{\hat{\sigma}_{HMt} + \hat{\sigma}_{\varepsilon t} \hat{\sigma}_{Mt}}{\hat{\sigma}_{Mt}^2}; \text{ and} \quad (\text{D12})$$

$$P_{L,t-1} = \frac{1}{f_t} \left\{ \hat{\mu}_{Ft} - \hat{\beta}_{Ft}^* (\hat{\mu}_{Mt} - f_t) \right\}. \quad (\text{D13})$$

APPENDIX E PRICING ALGORITHM

The pricing algorithm is as follows:

1. Preliminary specifications

1.1 Programmatic preliminaries

1.2 Specify the control variables (cf. ¶5.3):

- an indication whether the price to be calculated is that of accrued pensions or accruing pensions;
- a specification of the cohorts to be priced, by age and sex;
- the yield-curve points to be selected for the state-space vector (cf. ¶4.2);
- I , the number of primary simulations;
- J , the number of secondary simulations;
- n , the power used in the estimation of the year-end price ((B5) and (B6)); and
- E , the number of primary simulations used in the estimation of the year-end price (B12).

1.3 Specify the liabilities data:

- the valuation year;
- for each model-point cohort:
 - for each sex:
 - the number of members;
 - the accrued annual pension; and
 - for ages below the retirement age, the annual pension accruing per year.

1.4 Specify the benefits:

For the purposes of this paper the only item requiring specification was the retirement age.

1.5 Specify the liabilities valuation assumptions:

1.5.1 Salaries model:

parameters per section 2.2

1.5.2 Mortality model:

- parameters per section 2.4
- base year of the mortality table
- mortality table per Table A.3

1.6 Specify the model of assets & inflation:

1.6.1 Equilibrium model:

the parameters required per section C.1 of Appendix C.

1.6.2 Market-portfolio model:

the parameters required per section C.2 of Appendix C.

2. Preliminary calculations

2.1 Preliminary calculations: liabilities:

This involves the determination of the dimensions of the model-point data, the mortality table and hence the time T to the final liability cash-flow, relative to the

retirement age and the control variables specified in 1.2, as well as the following variables for the ages required:

- $\mu_{\zeta x}$ per (12);
- $\sigma_{\zeta x}$ per (13); and
- $\nu_{\{x\}}^{SAP}$ per (23).

2.2 Preliminary calculations: assets:

This involves the determination of the dimensions of the yield curves and the selected yield-curve points, as well as the following variables:

- $\sigma_{IM}(s)$ per (C2);
- $\sigma_{CM}(s)$ per (C3); and
- σ_{EM} per (C4).

2.3 Define dimensions of Sobol numbers and generate those required for the primary simulations

See section 4.5.

3. Primary simulations of state space

For $i = 1, \dots, I$:

3.1 Initialise

3.1.1 Initialise: assets:

The values of the following variables are reset to their values for $t = 0$:

- $Y_{It}(s)$;
- $Y_{Ct}(s)$; and
- $\delta_{I,t+1}(0)$.

3.1.2 Initialise: liabilities:

This involves resetting the age cohorts and the cumulative improvements in mortality to their original specifications

3.2 Proceed with simulation as follows:

For $t = 1, \dots, T - 1$:

3.2.1 Select Sobol numbers

3.2.2 Assets:

Calculate variables required per ¶¶C.4–C.6

Capture the resulting values of the following variables for use in the secondary simulations:

- $Y_{It}(s)$; and
- $Y_{Ct}(s)$.

3.2.3 Liabilities:

3.2.3.1 Liabilities: Initialise

This involves redetermining the dimensions of the model-Point data at the start of year t according to the attained ages of the cohorts.

3.2.3.2 Liabilities: salary increases:

Calculate the following variables:

- ξ_t per (7); and
- ζ_{xt} (separately for each cohort) per (17);

and hence the increased pensions for active members:

$$P_{x+1,t} = P_{x,t-1} \exp(\xi_t + \zeta_{xt}).$$

As noted in section 2.2, the salary increase in the year of age $(R - 1; R]$ is nil.

3.2.3.3 Liabilities: mortality:

For each sex and pensioner cohort age:

- Recalculate $v_{\{x\}+t}^{SAP}$ allowing for the cumulative mortality change to the start of the year per (22);
- Calculate the increased pension as:

$$P_{x+1,t} = P_{x,t-1} \exp(-v_{xt}^{SAP}).$$

3.2.3.4 Liabilities: pension increases:

Calculate the force of pension increase and hence the increased pensions for pensioners per (19) as:

$$P'_{x+1,t} = P_{x+1,t} \exp\{\max(0, -\gamma_t)\}$$

3.2.3.5 Liabilities: Determine cumulative mortality change to year-end:

χ_{vt} per (24).

3.2.3.6 Liabilities: record output:

- $P'_{x+1,t}$
- χ_{vt} .

4. Secondary simulations of state space and estimation of prices

4.1 Secondary simulations: initialise:

4.1.1 Index general state-space vector

This involves the determination of the fixed components of the state-space vector. (Variable components are dealt with in 4.2.1.1 below.)

4.1.2 Initialise variables

This involves the determination of the dimensions of the vectors and matrices to be used in the secondary simulations.

4.1.3 Generate Sobol numbers for secondary simulations

See section 4.5.

4.2 Secondary simulations

For $t = T, \dots, 1$:

4.2.1 Initialise year:

if $t < T$:

4.2.1.1 Define variable state-space dimensions at time $t - 1$

4.2.1.2 Determine state-space matrix at year-end

4.2.1.3 Calculate scaling factors

If $t > 1$, calculate:

- \bar{x}_d^* per (B11)
- $s_d^{(n)}$ per (B6); and
- w_{ij} per (B5).

4.2.1.4 Liabilities: initialise

This involves redetermining the dimensions of the model-point data at time t according to the attained ages of the cohorts as in 3.2.3.1.

Also, the components of the Sobol-number matrix that are required for the secondary simulations in year t are defined with reference to the redetermined dimensions of the model-point data.

4.2.2 Proceed with reference to primary simulations

If $t = 1$ then $I_t = 1$; otherwise $I_t = I$.

For $i = 1, \dots, I_t$:

4.2.2.1 Obtain information from primary simulations

If $t = 1$ then, for $s = 1, \dots, \tau$ and for each sex and each cohort x :

- $Y_{I,t-1}(s) = Y_{I0}(s)$ and $Y_{I,t-1}(s) = Y_{I0}(s)$ per 1.6.2 above;
- $\chi_{v,t-1} = 0$ per (24); and
- $P_{x,t-1} = P_{x0}$.

Otherwise $Y_{I,t-1}(s)$, $Y_{I,t-1}(s)$, $\chi_{v,t-1}$ and $P_{x,t-1}$ are obtained from 3.2.2 and 3.2.3.4.

4.2.2.2 Liabilities: cash flow at start of year

cf. Section 2.1

4.2.2.3 Reinitialise price vectors and Sobol argument

The values of p_j (B15) are set to null.

The commencing argument for reading Sobol numbers is reset to 0, so that, during each set of secondary simulations, the same set of Sobol numbers is read for each primary simulation i .

4.2.2.4 Proceed with secondary simulations

If $t < T$:

For $j = 1, \dots, J$:

4.2.2.4.1 Select Sobol numbers

4.2.2.4.2 Assets

Calculate variables required per ¶¶C.4–C.6.

Hence define the matrix \mathbf{V}_{ij} (cf. Appendix D).

4.2.2.4.3 Liabilities

4.2.2.4.3.1 Liabilities: initialise pensions

Set pensions equal to those obtained in 4.2.2.1 above.

4.2.2.4.3.2 Liabilities: salary increases

Follow the same procedure as in 3.2.3.2 above.

4.2.2.4.3.3 Liabilities: mortality

Follow the same procedure as in 3.2.3.4 above.

4.2.2.4.3.4 Liabilities: cash flow at year-end

cf. Section 2.1

4.2.2.4.3.5 Liabilities: pension increases

Follow the same procedure as in 3.2.3.3 above.

4.2.2.4.3.6 Liabilities: change in mortality

Record the cumulative mortality change to the end of

The year (i.e. χ_{vt}) for use in 4.2.2.4.3.7 below.

4.2.2.4.3.7 Liabilities: weighted average price at year-end
after cash flow

Determine x_t per (29).

cf. App. B

4.2.2.4.3.8 Liabilities: price at year-end before cash flow

Add cash flow per 4.2.2.4.3.6 to liabilities per

4.2.2.4.3.7

4.2.2.5 Calculate price at start of year after cash flow

Calculate $P_{L,t-1}$ per Appendix D.

4.2.2.6 Calculate price at start of year before cash flow

Add cash flow at the start of the year per 4.2.2.4.3.3.

4.2.3 Record price at start of year:

If $t = 1$ $p_L = P_{L,t-1}$

5. Print p_L .